

folkArt® *One
Stroke*™



Learn to paint with Donna Dewberry!



Donna Dewberry is the original creator of the One Stroke method of decorative painting. Donna makes learning this technique easy and fun! She's been teaching thousands of people across the world how to paint, for over 20 years, from the convenience of their own homes with full-length free YouTube painting lessons and reusable teaching guides. You'll be sure to learn something new in these curated and comprehensive painting kits. Explore all of Donna Dewberry's FolkArt One Stroke series' to create beautiful flowers and home decor.

ONE STROKE OF THE BRUSH



PREP



LOAD BRUSH

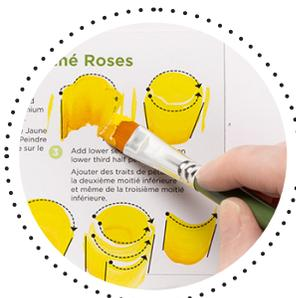

PRACTICE

The FolkArt One Stroke method is a painting technique where two colors are double loaded on to a brush and in one easy motion, you can create flowers, petals, leaves and more! Learn to blend, shade, and highlight with just one stroke of the brush. In each of Donna's series, she'll guide you through the step-by-step process of learning her technique.





ONE STROKE LEARN TO PAINT KITS

Join Donna Dewberry as she teaches you the magic of her One Stroke painting method. These comprehensive One Stroke lessons and customized product kits allow you to learn in the convenience of your own home. Lessons include full-length, free YouTube painting lessons and reusable teaching guides. Whether you're a novice or an experienced painter, you'll learn how to paint florals, birds, wreaths, and more in these lessons taught exclusively by Donna in these curated kits.

Explore Donna's exclusive One Stroke lessons at:
Plaidonline.com/brands/one-stroke

Flower of the Month

Learn to paint flowers the One Stroke way.



Wreath of the Month

Paint beautiful seasonal wreaths for every month of the year.



Hometown

Recreate hometown fixtures such as churches, barns, flowers & homes.



Birds and Blossoms

Learn to paint the birds and blossoms found in nature.



A-Z 50 Florals

Paint beautiful flowers from asters to zinnias.



100's
of lessons



NEW

A-Z 50 Florals Kit

99506

The FolkArt One Stroke A-Z 50 Florals Kit is everything you'll need to learn to paint beautiful flowers. From asters to zinnias, Donna's methods and guides give you the encouragement and training you need to paint your favorite flowers.



Kit Includes

10 - 2oz FolkArt Multi-Surface Colors



- | | | | | |
|----------------------|-------------------|---------------------|----------------------|-------------------|
| 2894
Wicker White | 2898
Magenta | 2911
Moon Yellow | 2910
Yellow Ochre | 2901
Apple Red |
| 2915
Citrus Green | 2985
Sap Green | 2926
Cobalt Hue | 2956
Violet Pansy | 2934
Licorice |

868
2oz Floating Medium



Storage Box



5pc One Stroke Specialty Brush Set



- | | | | | |
|--------------|---------------|-----------------|------------|-------------|
| 3/4"
Flat | 5/8"
Angle | 1/2"
Scruffy | 12
Flat | 2
Script |
|--------------|---------------|-----------------|------------|-------------|

8 1/2" x 5 1/2" Double Sided
50 Reusable Teaching Guides



50
FREE online
video lessons



Aster



Black Eyed Susan



Blanket Flower



Bluebell



Buttercup



Cabbage Rose



Calla Lily



Carnation



Cherry Blossom



Chrysanthemum



Columbine



Coneflower



Daffodil



Dahlia



Daisy



Delphinium



Dogwood



Forget Me Not



Foxglove



Fuchsia



Geranium



Gladiolus



Hibiscus



Hollyhock



Hyacinth



Hydrangea



Iris



Jasmine



Lavender



Lilac



Lily of the Valley



Magnolia



Marigold



Morning Glory



Pansy



Paperwhite



Peace Rose



Petunia



Poppy



Queen Anne Lace



Ranunculus



Sunflower



Sweet Pea



Thistle



Tiger Lily



Trumpet Flower



Tulip



Wild Rose



Wisteria



Yarrow



Flower of the Month

99228

Recreate the flowers found in nature with the FolkArt One Stroke Flower of the Month Kit. This kit contains all the acrylic paints, paint brushes and other supplies needed to follow along with Donna Dewberry as she walks you through each month's flower painting.



Kit Includes

12 - 2oz FolkArt Multi-Surface Colors



10pc One Stroke Specialty Brush Set



868
2oz Floating Medium



34919
Sponge



8½" x 11" Double Sided
12 Reusable Teaching Guides

Limited Edition Signed Folder

January
Carnation



February
Violet



March
Daffodil



April
Sweet Pea



May
Lily of the Valley



June
Rose



July
Larkspur



August
Gladiolus



September
Morning Glory



October
Marigold



November
Chrysanthemum



December
Paper White





Wreath of the Month

99436

In this interactive FolkArt One Stroke Wreath of the Month Kit, Donna Dewberry will demonstrate how to paint beautiful floral wreaths for every month of the year.



Kit Includes

12 - 2oz FolkArt Multi-Surface Colors



10pc One Stroke Specialty Brush Set



12
FREE online
video lessons

Designed to work with
our exclusive
surfaces



868
2oz Floating Medium



3081
2oz Treasure Gold

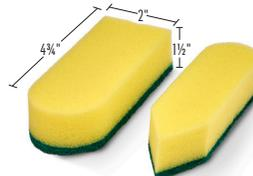

1195
Sponge Painters



8½" x 11" Double Sided
12 Reusable Teaching Guides

Limited Edition Signed Folder

January
Winter Wreath



February
Rose Wreath



March
Greenery and Blossoms



April
Tulips All Around



May
May Daisies



June
June Zinnias



July
Red and White Plus Blue Hydrangeas



August
Sunflower Wreath



September
Harvest Wreath



October
Autumn Poppies Wreath



November
Warm Magnolias Wreath



December
Winter Splendor Poinsettias





Hometown

99492

Everything you need to paint your hometown scene is nestled in The FolkArt One Stroke Hometown Kit. Follow along with Donna as she walks you through the Hometown painting video series to create 12 unique paintings inspired by home.



Kit Includes

12 - 2oz FolkArt Multi-Surface Colors



10pc One Stroke Specialty Brush Set



9- 8 1/2" x 11" Line Art Pattern Sheets



12
FREE online
video lessons

Limited Edition Signed Folder



8 1/2" x 11"
Alphabet Stencils



868
2oz Floating Medium



8 1/2" x 11" Double Sided
12 Reusable Teaching Guides

January



February



March



April



May



June



July



August



September



October



November



December





Birds and Blossoms

90284

With every lesson in our FolkArt One Stroke Birds and Blossoms Kit, Donna guides you, step by step, through the process of painting beautiful birds and blossoms. If you listen carefully, you may even hear the sweet song of each bird!



Kit Includes

12 - 2oz FolkArt Multi-Surface Colors



10pc One Stroke Specialty Brush Set



6
FREE online
video lessons

Designed to work with our exclusive surfaces

Limited Edition Signed Folder



868
2oz Floating Medium



8½" x 11" Double Sided
12 Reusable Teaching Guides

Cardinal



Bluebird



Goldfinch



Toucan



Owl



Blue Jay



Brushes

FolkArt One Stroke brushes are designed by Donna for the One Stroke painting technique.

These premium brushes are perfect for blending, shading and highlighting. Add these must have brushes, designed for artists of all skill levels, to your collection. Choose individual brushes or a curated set, all hand-picked by Donna.



Handle Designs Painted by Donna

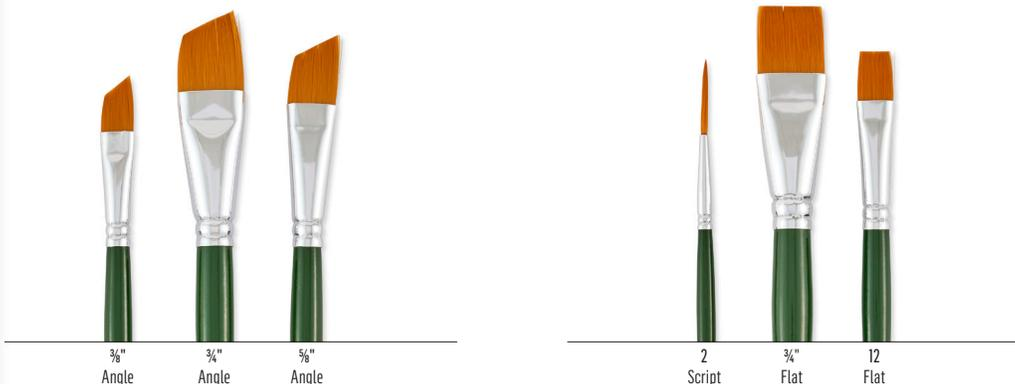

1278
ONE STROKE ANGLE BRUSH SET

- Premium quality synthetic bristle brushes
- Angled brushes for precise, sharp strokes
- Designed by Donna Dewberry
- 3 piece brush set

1171
ONE STROKE BASIC BRUSH SET

- Premium quality synthetic bristle brushes
- Flat and Liner brushes for precise, sharp strokes
- Designed by Donna Dewberry
- 3 piece brush set

1059
ONE STROKE VALUE PACK BRUSH SET

- Premium quality natural and synthetic bristles
- Designed by Donna Dewberry
- Complements the One Stroke painting techniques
- 10 piece brush set



1900
ONE STROKE BRUSHES-SIGNATURE SET

- Premium quality synthetic and natural bristle brushes
- Specially designed and decorated handles
- Ideal for One-Stroke techniques including blending, shading and highlighting
- 13 piece brush set



1293
ONE STROKE FEATHER BRUSH 1/2"

- Rake-like, premium quality synthetic paintbrush
- Use for creating fine details and feathered edges



1272
ONE STROKE SCRIPT LINER #2

- Premium quality synthetic bristle brush
- Ideal for fine details like vines, curlicues, script and letters



1058
ONE STROKE FLAT #12

- Premium quality synthetic bristle brush
- Ideal for straight edges, bold strokes, washes of color, double and triple loading, blending, chisel edge work and floating colors



1184
ONE STROKE FLAT #1

- Premium quality synthetic bristle brush
- Ideal for straight edges, bold strokes, washes of color, double and triple loading, blending, chisel edge work and floating colors



1196
ONE STROKE FAN BRUSH

- Premium quality synthetic bristle fan-shaped brush
- Create perfectly blended and feathered colors
- Use for grasses, trees, branches, hair and fur



1204
ONE STROKE FLAT #16

- Premium quality synthetic bristle brush
- Ideal for straight edges, bold strokes, washes of color, double and triple loading, blending, chisel edge work and floating colors



1206
ONE STROKE SCRUFFY 1/2"

- Premium quality natural bristle brush
- Create texture, shade and pounce flower centers
- Ideal for painting mosses, wisteria, grasses, hair and fur

Tools

Donna Dewberry's custom designed tools were created to make learning and painting the FolkArt One Stroke technique easy and fun.

Save time and resources with durable tools that preserve paints and brushes. Add one or all of these must-have tools and start painting!

Rounded-tip sponge covers large surfaces

Rough side to produce a different texture

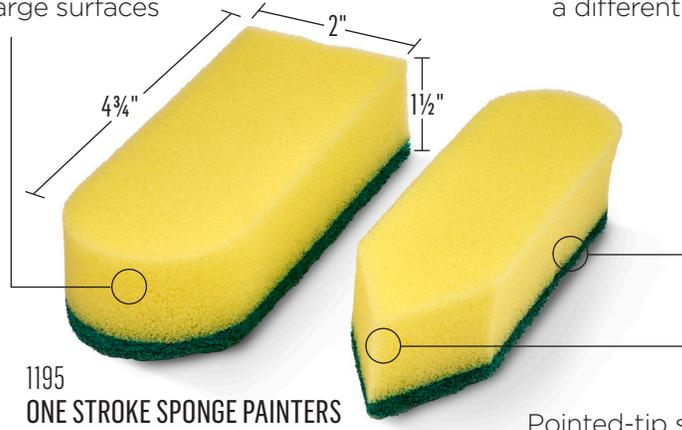

1195 ONE STROKE SPONGE PAINTERS

Pointed-tip sponge delivers paint into tight corners

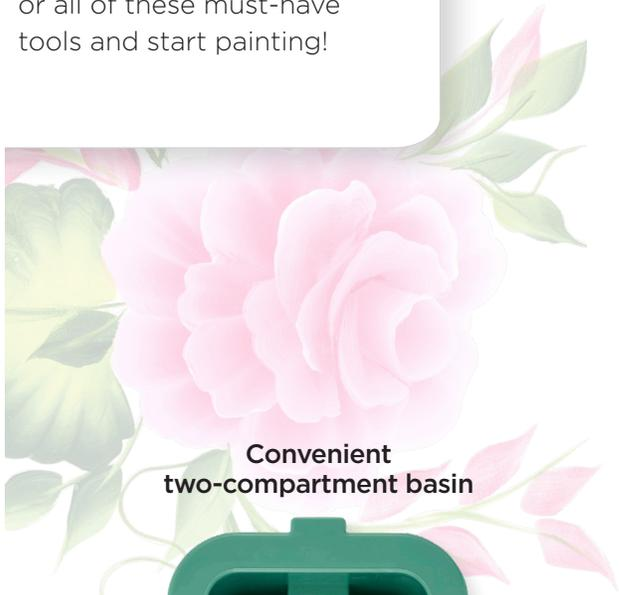

Convenient two-compartment basin



Ridges for cleaning

Store bristles up

Keeps brushes suspended in water



Dry bristles down

Holds up to 17 Brushes at once

1200 ONE STROKE BRUSH BASIN

Create the Ultimate Painting Experience

Combine the One Stroke Double Loading Carousel with the One Stroke Palette to build an essential workspace for creating beautiful flowers and home decor.



1220
ONE STROKE DOUBLE
LOADING CAROUSEL



1001
ONE STROKE PALETTE

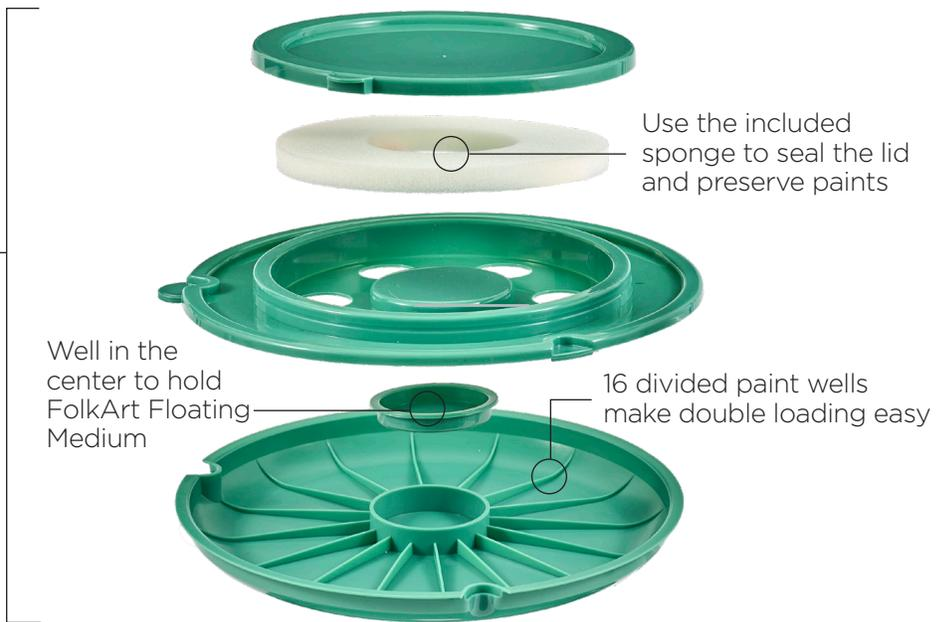

Double Loading Carousel fits into the center of the Palette and locks into place*



*Sold separately

Surfaces

These exclusive plaques and shapes are perfect for creating signs, coasters, gifts and home decor. Use the pre-drilled holes in the plaques to hang your art on a door or in a window space.

Ready to Craft
reversible
surfaces

Pre-drilled holes for hanging
in different orientations

Paint, decoupage, stencil and
woodburn on any of these wood
shapes to express your creativity

Indoor/Outdoor

Scalloped edges

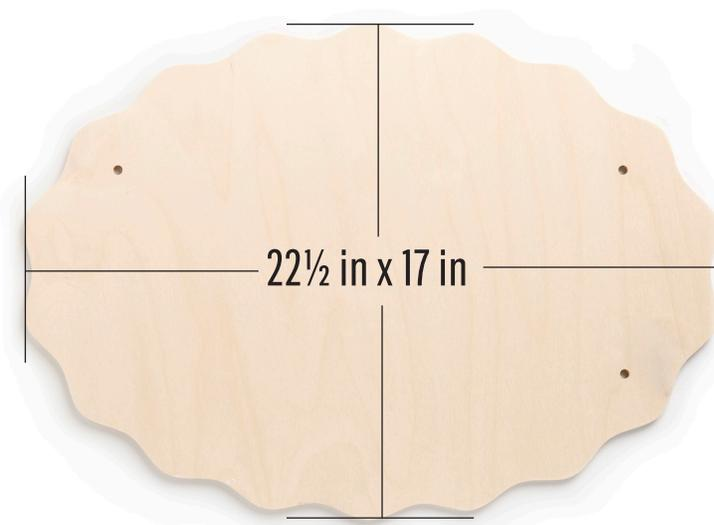

99462
ONE STROKE OVAL SURFACE

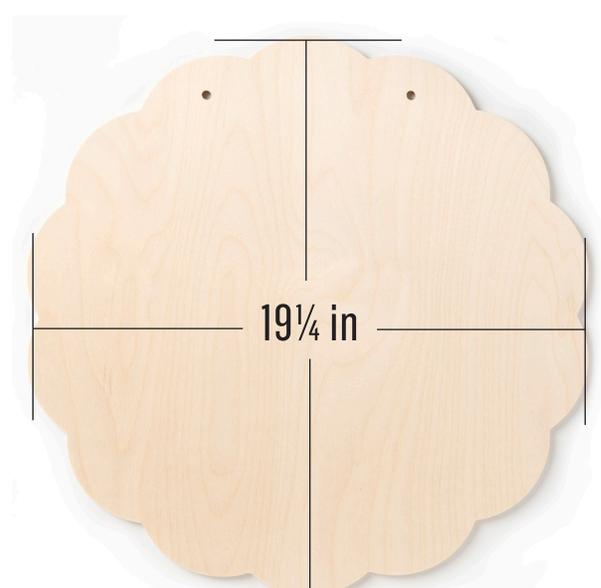

99458
ONE STROKE CIRCLE SURFACE

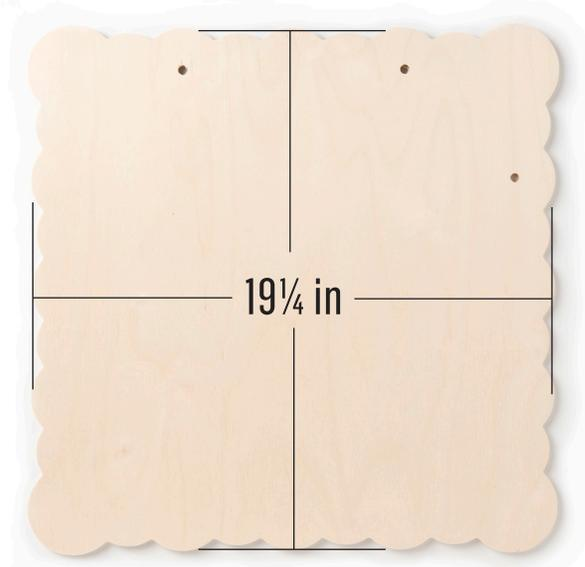

99459
ONE STROKE SQUARE SURFACE

90285

ONE STROKE 10 PC SURFACES KIT

- Paint One Stroke Birds and Blossoms on the variety of unfinished wood surfaces included in this kit
- Ideal for painting, découpage, stenciling and woodburning
- Create signs, coasters, gifts and decor
- Ready to craft



PAIRS GREAT WITH THE
BIRDS AND BLOSSOM PAINT KIT

1 pc

12 in x 12 in

.....
Scalloped Wood Panel

1 pc

12 in x 12 in

.....
Square Wood Panel

2 pc

15.9 in x 11.88 in

.....
Pallet Plaque

2 pc

10.5 in x 13.125 in

.....
Plank with Bark

4 pc

4 in x 4 in
.....
Wooden Coasters



FolkArt is so much more than a brand of premium paints and brushes. FolkArt is a part of the creative community. Let's share inspiration, information and the enthusiasm we feel for creating art.

Look to our social media channels for fresh ideas, product knowledge and FREE tutorials.

